



**Section Twenty Nine
The Hillcrest of Gleannloch Farms**

RESIDENTIAL DESIGN GUIDELINES

Gleannloch Farms Community Association Inc.

FOREWORD

Gleannloch Farms is being developed as a master planned residential community. This document is presented as a minimum set of development guidelines and standards for Gleannloch Farms Section Twenty-nine - The Hillcrest. The intended use is to provide an understanding of responsibilities of the Developer and the Builder, to develop a framework to illustrate and define design objectives and requirements to create a unified, harmonious setting for divergent lifestyles and tastes inherent in a planned development.

These guidelines are supplemental to The Declaration of Covenants, Conditions and Restrictions, and are to be used by the Architectural Review Committee (ARC) in review of plans submitted, as required by builders. Non-compliance with these guidelines is grounds for disapproval of plans. These guidelines are also for use as a standard for future compliance to maintain the integrity of the community.

Illustrative examples and descriptions are meant to insure an orderly, well-maintained sense of an attractive environment for the residents of Gleannloch Farms.

Gleannloch Farms is located in Northwest Harris County, Texas in the extra-territorial jurisdiction of the City of Houston. Rules and regulations of these entities supercede the residential guidelines.

SITE LAYOUT

Residential Driveway/Garage Placement for Section Twenty-nine - The Hillcrest of Gleannloch Farms

The following is a list by lot and block number dictating location of residential driveways and garages. Locations of driveways and garages have been determined for reasons of aesthetics, vehicular circulation and safety.

The designation of left, right or optional is determined by viewing the lot from the street right - of-way facing the lot. Side lot loading is not permitted. A variance request, in writing, may be considered for certain lots having frontage on two sides if the garage is set back from the right-of-way twenty feet (20').

Left Side: *Block 1* – lot 1, 23
 Block 2 – lot 16
 Block 3 – lots 1, 7
 Block 4 – lot 1, 5

Right Side: *Block 1* – lots 22, 37
 Block 2 – lot 1, 17
 Block 3 – lot 10, 15, 17, 28, 32,
 Block 4 – lot 4

All other lots have optional driveway placement.

****Side Lot Loading is not permitted in this section.**

****Rear garages are not permitted on Golf Course lots.**

SITE LAYOUT

Fencing • The Hillcrest of Gleannloch Farms

The developer shall be responsible for installing perimeter fencing including wood posts, rails and pickets, stone columns and iron fencing in all landscape reserves (except along golf course), and at the rear and sides of the following lots.

Block 1 - lots 1, 2, 3, 4, 5, 6, 7

Block 2 - lots 1, 2, 3, 4, 5

The builder shall be responsible for installing a 6' perimeter wood fence, with the good side facing out on the side of the following lots.

Block 1 - lots 12, 22, 23, 37

Block 2 - lots 6, 7, 8, 9, 10, 11, 12, 13, 14, 15, 16

Block 3 - lots 1, 7, 10, 15, 17, 28

Block 4 - lot 1, 4, 5

The builder shall be responsible for installing a 48" high iron fence on the following lots.

Block 2 - lots 17, 18, 19, 20, 21, 22, 23

The developer shall be responsible for installing a split rail wood fence in the following areas.

Block 2 - Reserve 'A'

All other interior, rear and side fencing shall be the responsibility of the builder. Wood fences in interior lots shall be constructed using alternating panels as illustrated.

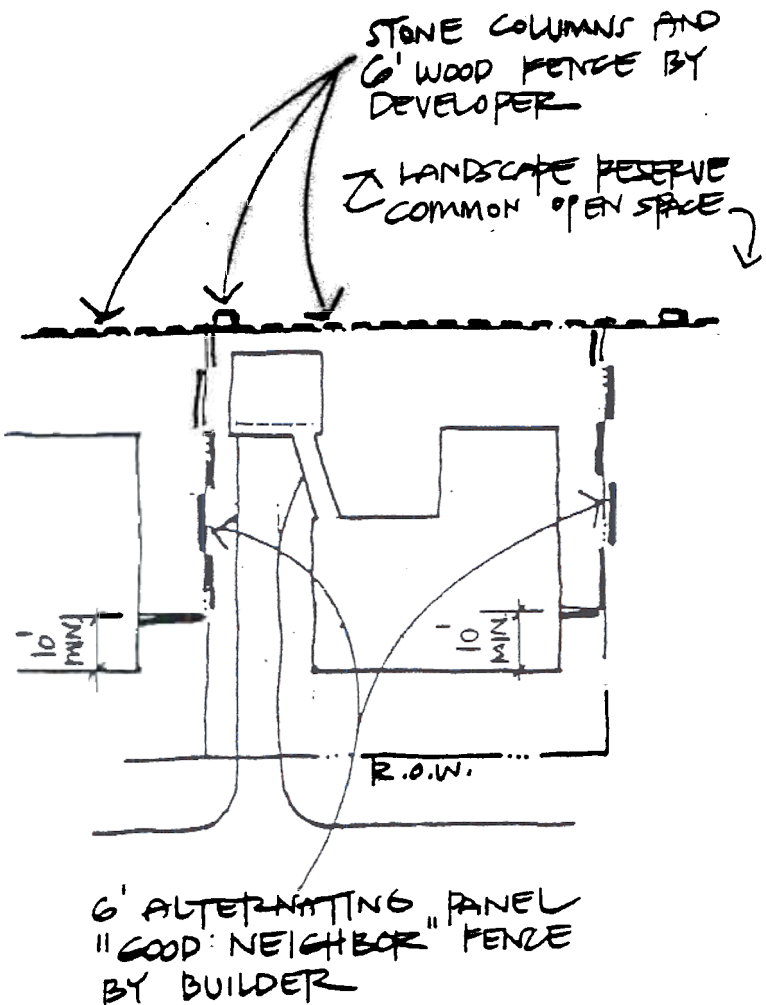

DEVELOPER PERIMETER FENCE

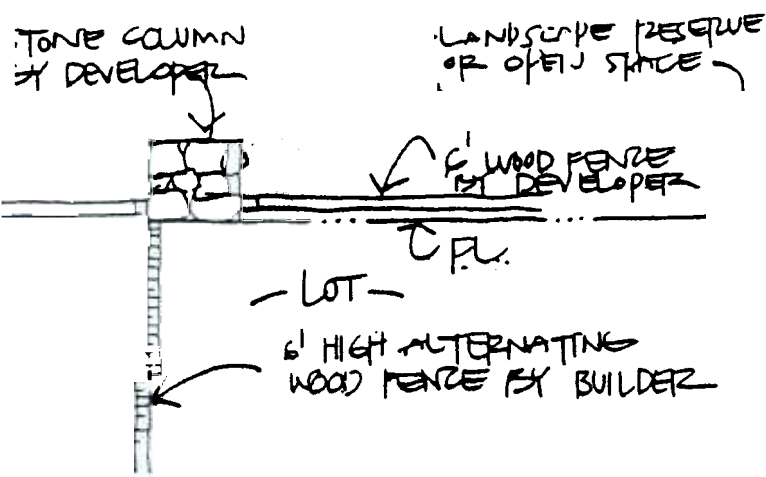

SITE LAYOUT

Wrought Iron Fence

Wrought iron fences are to be installed as to the design standards illustrated. Panels bolted instead of welded to posts are recommended, for ease of maintenance and access, but welded panels are acceptable. Iron should be primed and painted.

Set iron posts in concrete footing.

All fences are to be designed as shown at left. No other wrought iron fence designs will be approved.

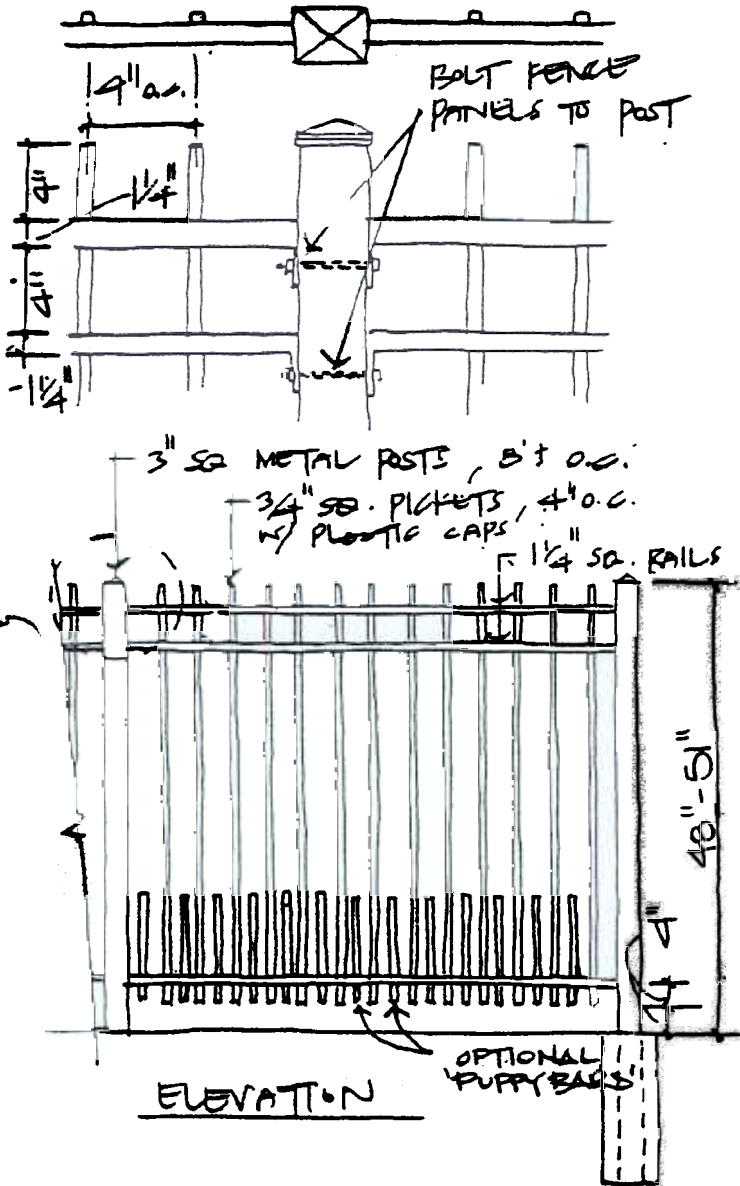

SITE LAYOUT

Golf Course Fencing

Lots backing onto the golf course are to be fenced with wrought iron of a standard design as shown. This fencing is required to promote a feeling of spaciousness for the lots and the open space. Rear and side lot fencing is further defined in each neighborhood's supplemental guidelines.

The back yards of these lots must be treated in the same way as the fronts of the lots. Front yard must be planted with solid sod St. Augustine grass. Back yards may be planted with Bermuda grass or shrubs and groundcover. The back yards will be in full view of residents, guests and golfers. Provisions are made in these guidelines for privacy fencing or screening.

To open up the area and to avoid creating an alley effect, rear and side lot lines are required to be fenced with a 48" iron fence (not to exceed 51" above existing grade) using the design illustrated in the fence section. Iron fence is to return twenty feet (20') from the back of the lot toward the front of the residence.

Privacy fencing is permitted, but must be approved at the discretion of the ARC. Dog kennels, storage yards, wood piles, etc. are not to be visible from public view. Creating and maintaining a backyard that is viewed from open space and from nearby residences offers the chance for special design concepts.

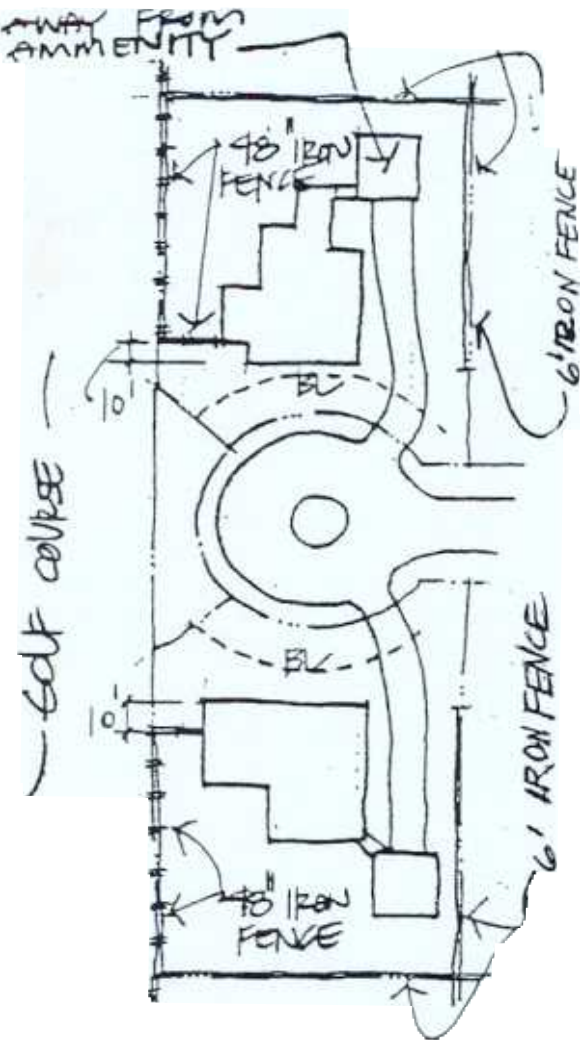

LOTS SIDING ON GOLF COURSE

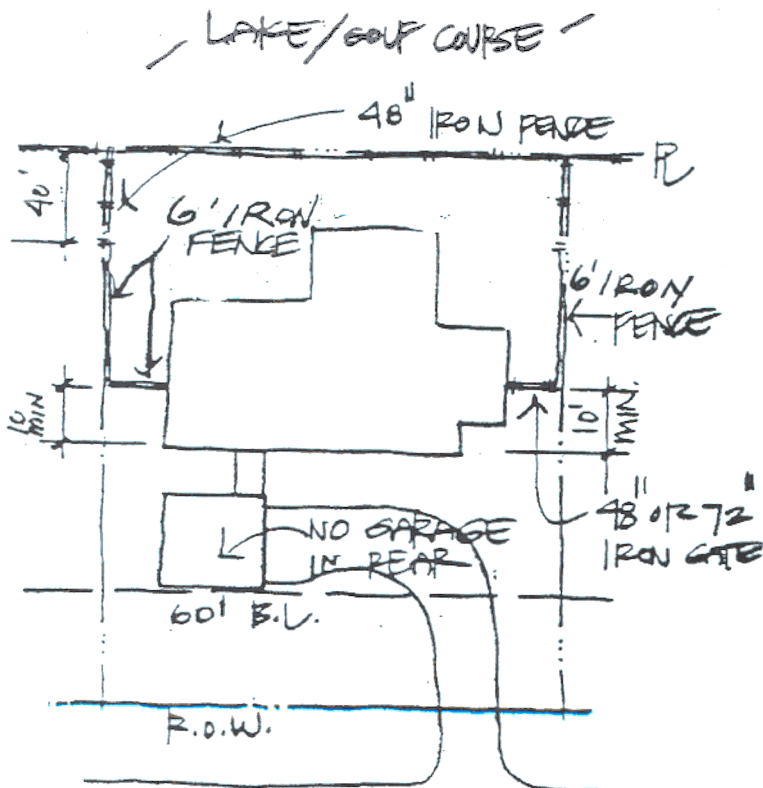

LOTS BACKING ON GOLF COURSE

SITE LAYOUT

Golf Course Lots

Lots adjacent to the Gleannloch Farms Golf Course are to be developed to derive the full potential of open space and views of golfing activities. Therefore the residences and grounds should be equally pleasing when viewed from the golf course.

The golf course has been designed using generally accepted criteria for golf course subdivisions, with adequate distances between fairways and residential lots. Design consideration for buildings, site layout and landscape planting should be addressed to protect against the possibility of errant golf balls. Shatter resistant glass for windows is strongly recommended for glass exposed to possible golf ball damage. Strategic siting and tree planting can be accomplished for additional safeguards.

Fencing of property lines adjacent to the golf course must be done according to the design criteria, illustrated in the fence section, by the builder or lot owner.

No detached rear garages are permitted on golf course lots.

SITE LAYOUT

Water Wells

Private water wells are prohibited on all residential lots in Gleannloch Farms Subdivision, regardless of lot size. Prohibited water wells include those intended as a source of water for irrigation, ponds, swimming pools, heat exchange air conditioning systems and potable water. All water use in Gleannloch Farms Subdivision is under the jurisdiction of Harris County Municipal Utility District No.367.

ARCHITECTURE

Mailboxes

All mailboxes are to be of the design shown at left, model #4430 "antique brass mailbox" mounted on #4895 in-ground mounted post. Mailbox and post available through:

"Salsbury Industries" phone # 1-800-MAILBOX
1010 East 62nd Street
Los Angeles, CA 90001
www.mailbox.com

Mailbox and post are both to be antique brass by manufacturer.

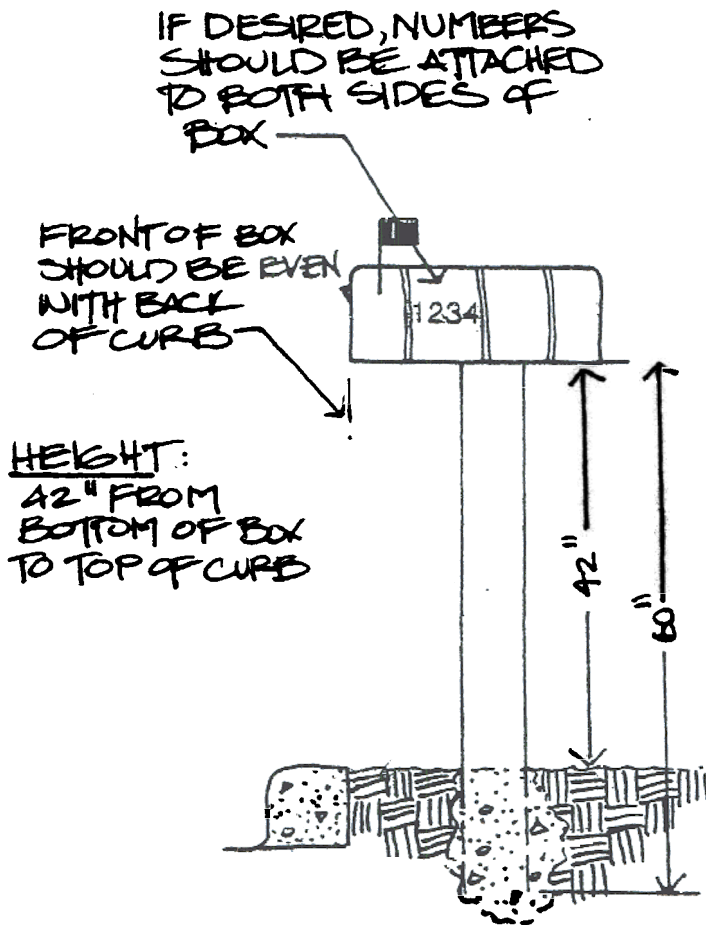
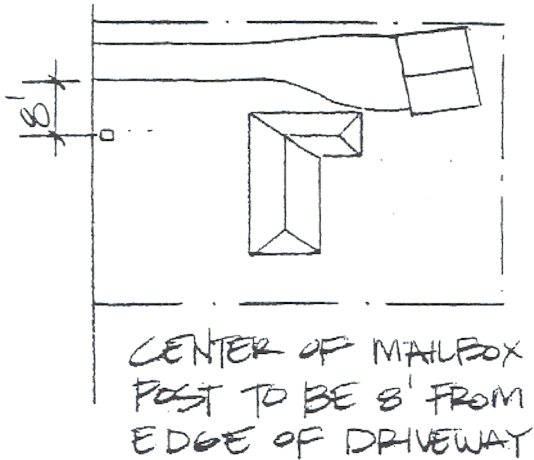

LANDSCAPE

Minimum Residential Landscaping Requirements • Lots 70' - 75' Wide

TREES

Three machine dug and two thirty gallon (30 gal.) container grown trees selected from the plant material list (preferred specimen trees) in the Landscape section of the Gleannloch Farms Residential Guidelines are required on lots 70' - 75' wide. It is recommended that at least one of the required trees be a loblolly pine or oak tree. The required trees must be a minimum of 4" caliper. When lots front and side on two streets, there shall be an additional three trees for side yard. Lots adjoining golf course, lakes or open spaces require two additional trees in rear or side yard. Pine trees are preferred, but other large trees of equal size from the approved plant list, may be considered for variances by the ARC.

SHRUBS

Lots 70'-75' wide require the planting of a minimum of 40 small one gallon shrubs and 20 large five gallon shrubs.

Planting beds are to be curvilinear with the shrubs massed in tiers - smaller shrubs in the front of the bed. Groupings of shrubs of the same species provide a substantial look. A single row of foundation planting is not acceptable. Radius beds 10' minimum from building and vary widths of beds. Mulch all beds with 2" shredded pine bark.

No gravel or rock of any size or color is permitted for use or substitution for shrubs, ground cover, mulch, or grass lawns. Specimen boulders and stone borders are permitted.

All grass visible from the street is to be St. Augustine, (solid sod).

Plants used as minimum requirements shall be selected from the approved plant list.

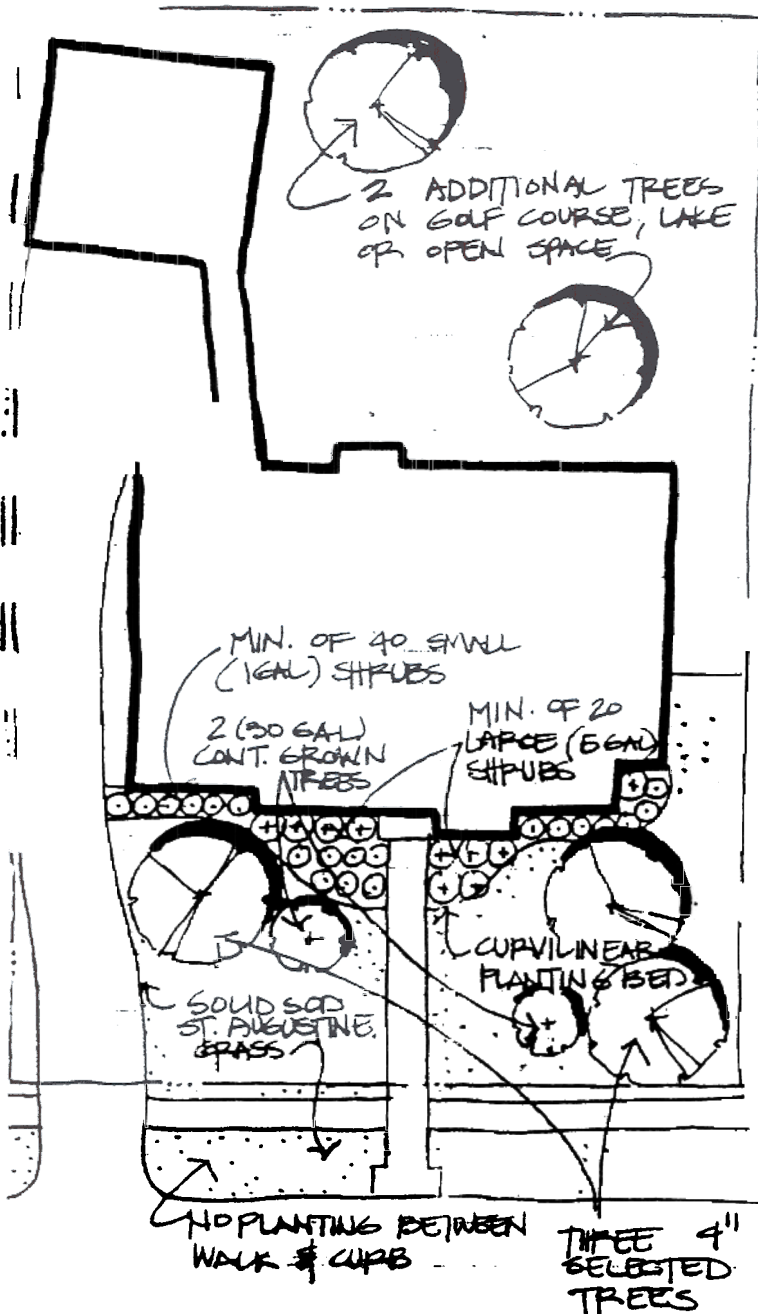

LANDSCAPE

Minimum Residential Landscaping requirements •
Lots 80' Wide & Over

TREES

Three machine dug and two thirty gallon (30 gal.) container grown trees selected from the plant material list (preferred specimen trees) in the Landscape section of the Gleannloch Farms Residential Design Guidelines are required on lots 80' wide and over. It is recommended that at least one of the required trees be a loblolly pine or oak tree. The required trees must be a minimum of 4" caliper. When lots front and side on two streets, there shall be an additional three trees for side yard. Lots adjoining golf course, lakes or open spaces require three additional trees in rear or side yard. Pine trees are preferred, but other large trees of equal size from the approved plant list, may be considered for variances by the ARC.

SHRUBS

Lots 80' wide and over require the planting of a minimum of 60 small one gallon shrubs and 30 large five gallon shrubs.

Planting beds are to be curvilinear with the shrubs massed in tiers - smaller shrubs in the front of the bed. Groupings of shrubs of the same species provide a substantial look. A single row of foundation planting is not acceptable. Radius beds 10' minimum from building, and vary widths of beds. Mulch all beds with 2" shredded pine bark.

No gravel or rock of any size or color is permitted for use or substitution for shrubs, ground cover, mulch or grass lawns. Specimen boulders and stone borders are permitted.

All grass visible from the street is to be St. Augustine, (solid sod).

Plants used as minimum requirements shall be selected from the approved plant list.

