

**Section Sixteen**  
**The Manor Estates of Gleannloch Farms**  
Supplement to Residential Design Guidelines

In addition to the Residential Design Guidelines for Gleannloch Farms, these are “Village” specific requirements.

No two residences in this section may have the same exterior elevations or floor plan.

Sidewalks are required in this section.

Metal roofs *may* be approved by variance only.

No siding is permitted in this section.

No chimneys faced with siding are allowed in this section.

Certain lots will have golf course views and are required to have iron fencing at the rear or side lot lines as appropriate to preserve views.

All lots have a 7' interior side setback.

Specifics for fencing and driveway location are noted in the following pages.

**NO** construction access is permitted through golf course, reserves or lake easements.

## FOREWORD

---

Gleannloch Farms is being developed as a master planned residential community. This document is presented as a minimum set of development guidelines and standards for Gleannloch Farms Section Sixteen – The Manor Estates. The intended use is to provide an understanding of responsibilities of the Developer and the Builder, to develop a framework to illustrate and define design objectives and requirements to create a unified, harmonious setting for divergent lifestyles and tastes inherent in a planned development.

These guidelines are supplemental to The Declaration of Covenants, Conditions and Restrictions and the Gleannloch Farms Residential Design Guidelines and are to be used by the Architectural Review Committee (ARC) in review of plans submitted, as required by builders (Copies of these guidelines may be obtained from Association Management, Inc 713-932-1122). Non-compliance with these guidelines is grounds for disapproval of plans. These guidelines are also for use as a standard for future compliance to maintain the integrity of the community.

Illustrative examples and descriptions are meant to insure an orderly, well-maintained and attractive environment for the residents of Gleannloch Farms.

The Manor Estates is meant to be a gated community of exclusive residences within Gleannloch Farms. Designs with front elevations that maximize lot frontage and streetscape opportunities are encouraged.

Gleannloch Farms is located in Northwest Harris County, Texas in the extra-territorial jurisdiction of the City of Houston. Rules and regulations of these entities supercede the residential guidelines.

## SITE LAYOUT

### Residential Driveway/Garage Placement for The Manor Estates of Gleannloch Farms

To achieve the exclusive Custom Home concept for the Manor Estates of Gleannloch Farms, the relationship of garages to the residence and adjoining lots, street rights of way and the golf course is of special importance. Designs that eliminate or minimize the public view of garages are preferred. Front loaded garages are discouraged. Garages, where visible to the public, shall have separate doors for each car. Double doors may be approved at the discretion of the ARC.

Side loaded garages should be set back at least ten feet (10') from the principal elevation of the house or set 10' in front of the house. All side loaded garages should have a 2' shadow box type overhang in front. See diagram at left.

Where it is necessary to have a front loaded garage, the garage must be set back at least twenty feet (20') from the principal elevation of the house. In addition, an architecturally compatible roof overhang (porte cochere) a minimum of eight feet (8') in depth is required. For every additional 1' garage is set back from principal elevation, the overhang may be reduced by 1', but may never be less than three feet (3'). To minimize and lessen the impact of front loaded garages, the location of side yard fences, the use of wing walls and other screening devices may be considered for lot specific ARC approval.

Rear garages are not permitted on any lots backing the golf course or lake.

The following is a list by lot and block number dictating location of residential driveways and garages. Locations of driveways and garages have been determined for reasons of aesthetics, vehicular circulation and safety.

The designation of left, right or optional is determined by viewing the lot from the street right -

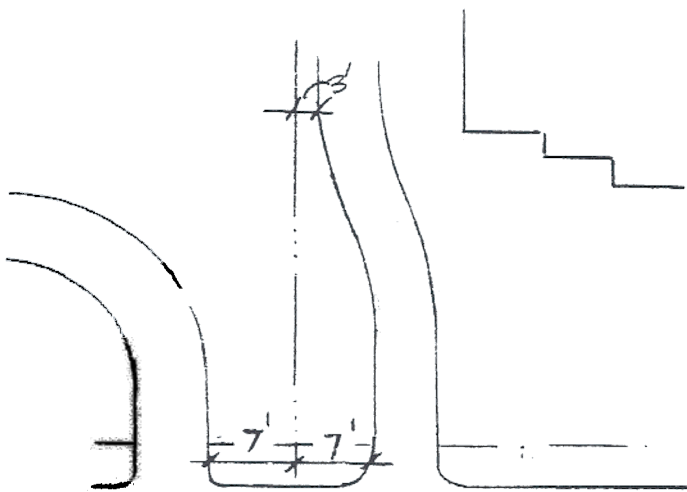

ADJACENT DRIVEWAYS

of-way facing the lot. Side lot loading is not permitted. A variance request, in writing, may be considered for certain lots having frontage on two sides if the garage is set back from the right-of-way twenty-five feet (25').

Left Side: *Block 1* – lot 30

Right Side: *Block 1* - lots 4, 24, 26

Optional: *Block 1* - lots 1, 2, 3, 5, 6, 7, 8, 9, 10, 11, 12, 13, 14, 15, 16, 17, 18, 19, 20, 21, 22, 23, 25, 27, 28, 29  
*Block 2* - lots 1, 2, 3, 4

Side Lot loading is not permitted in this section.

\*\*\*\*Driveway side designations apply only to lots without circular drives.

Driveway construction may be of concrete construction with an approved border treatment, however, driveways constructed completely of concrete pavers or stamped concrete are the preferred treatments. Acceptable border treatments include: concrete pavers, stone or a colored concrete band (min. 4" x 4"). No gravel or asphalt driveways are permitted.

Driveways may be no closer than seven feet (7') to side property lines at the point where they enter the property from the street. They may be transitioned back to the side property line, but can be no closer than three feet (3'). Garages must be a minimum of 7' from side property line, but at least 15' is preferred. Corner lot garages must be set back 25' from street.

Garage doors must be paneled and insulated. Custom doors are encouraged.

Corner lots may not have side facing garages.

48" IRON FENCE BY BUILDER  
PER RESIDENTIAL DESIGN  
GUIDELINES

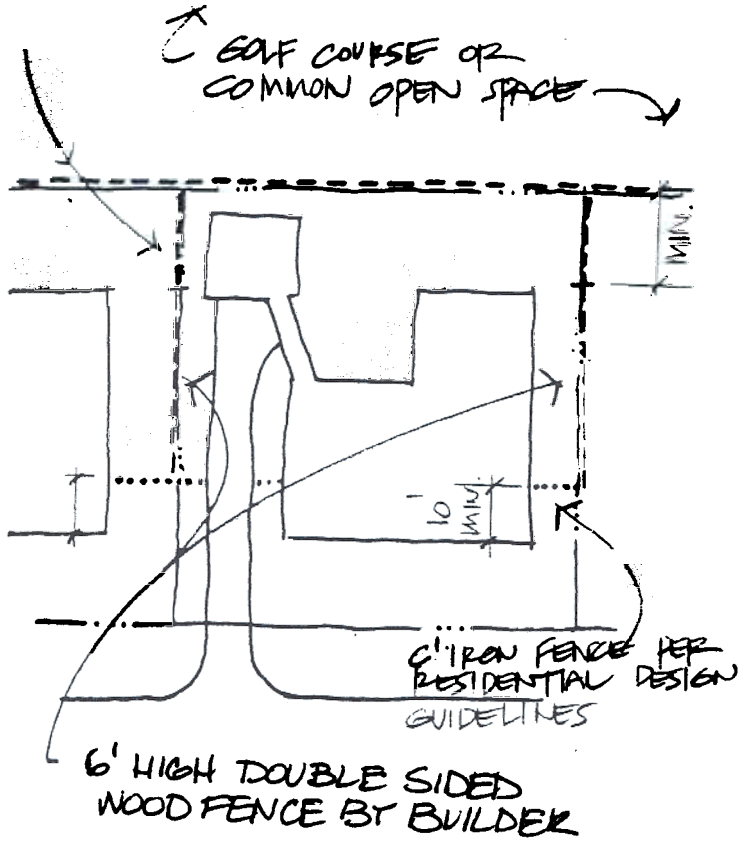

# SITE LAYOUT

Fencing • The Manor Estates of Gleannloch Farms

The developer shall be responsible for installing perimeter stone or masonry fencing at the rear or side of the following lots:

*Block 1* – lots 14(southeast corner along Gleannloch Forest Dr.), 15, 16, 17, 18, 19, 20, 21

The developer shall be responsible for installing perimeter fencing including wood posts, rails and pickets, and stone columns in all landscape reserves (except along golf course), at the rear and sides of the following lots.

The builder shall be responsible for installing perimeter fencing as shown with the good side facing out at the rear or side of the following lots:

*Block 1* – lots 24, 26, 30 (east side)

The builder shall be responsible for installing a 48" high iron fence on lots siding or backing the lake or golf course for the following lots. A 48" high iron fence shall extend from the rear property line to a minimum distance of 40' towards the front of the property on lake lots and 25' on golf course lots.

*Block 1* - lots 1, 2, 6, 7, 8, 9, 10, 11, 12, 13, 14

*Block 2* - lots 1, 2, 3, 4

All interior, rear and side fencing shall be the responsibility of the builder. Wood fences in interior lots shall be constructed using a double sided wood fence as shown on the next page. A 6' iron fence shall run parallel to front elevation at the sides of the residence.

All 48" iron fence adjacent to golf course or lakes shall match the iron fence detail shown on page 17 of the Gleannloch Farms Residential Design Guidelines and page 7 of this supplement.

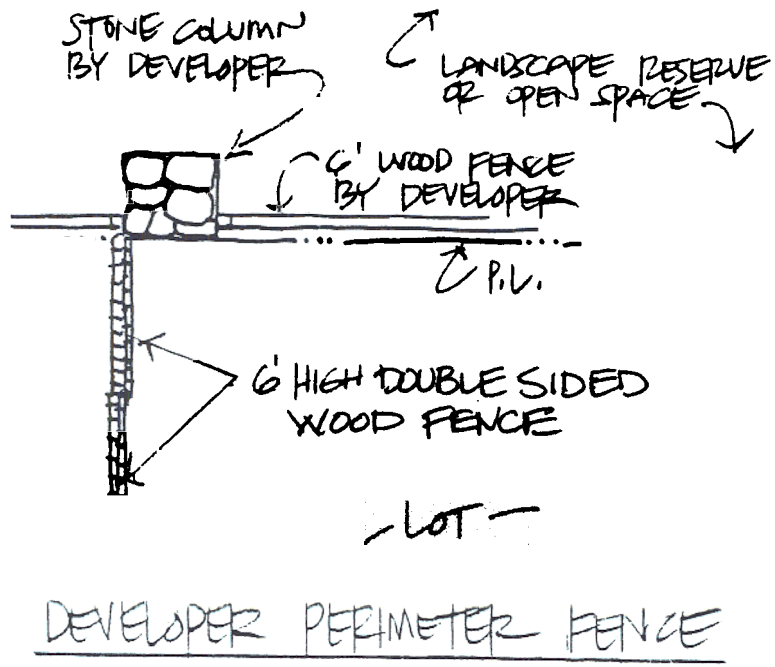

# SITE LAYOUT

## Double sided wood fence

The builder shall be responsible for installing a 6' double sided wood fence with cap as shown in the design to the left, on all interior lot lines in section 16.

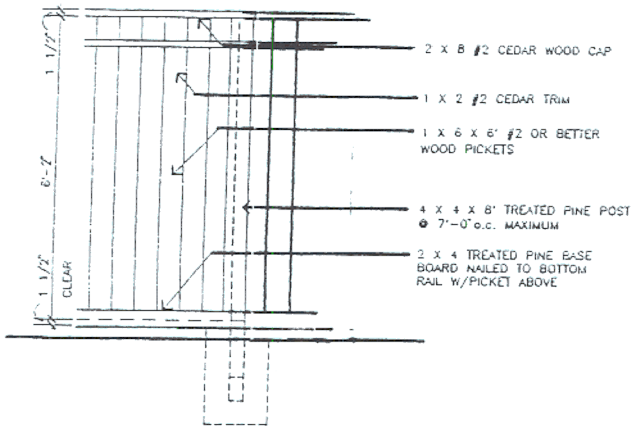

**DOUBLE SIDED WOOD FENCE - ELEVATION**

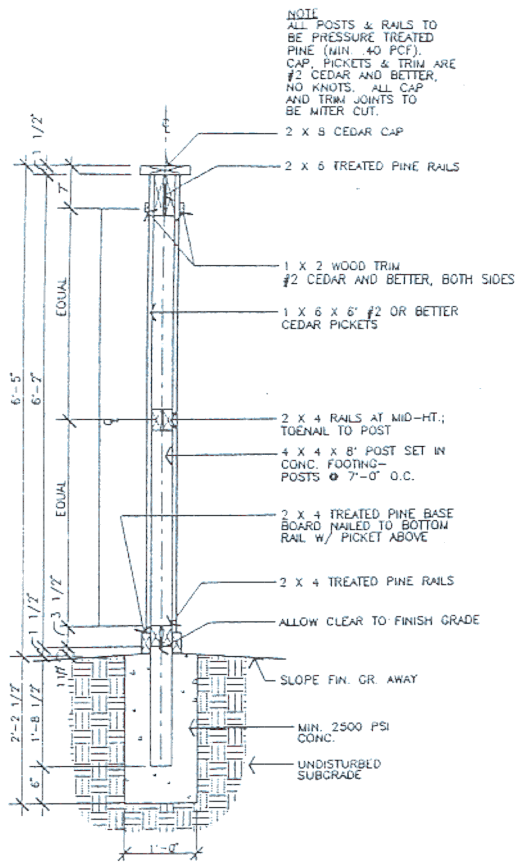

**DOUBLE SIDED WOOD FENCE - SECTION**

# SITE LAYOUT

## Wrought Iron Fence

Wrought iron fences are to be installed as to the design standards illustrated. Panels bolted instead of welded to posts are recommended, for ease of maintenance and access, but welded panels are acceptable. Iron should be primed and painted semi-gloss black. Attach panels to stone columns using lead expansion anchors and galvanized bolts.

Set iron posts in concrete footing.

All fences are to be designed as shown at left. No other wrought iron fence designs will be approved.

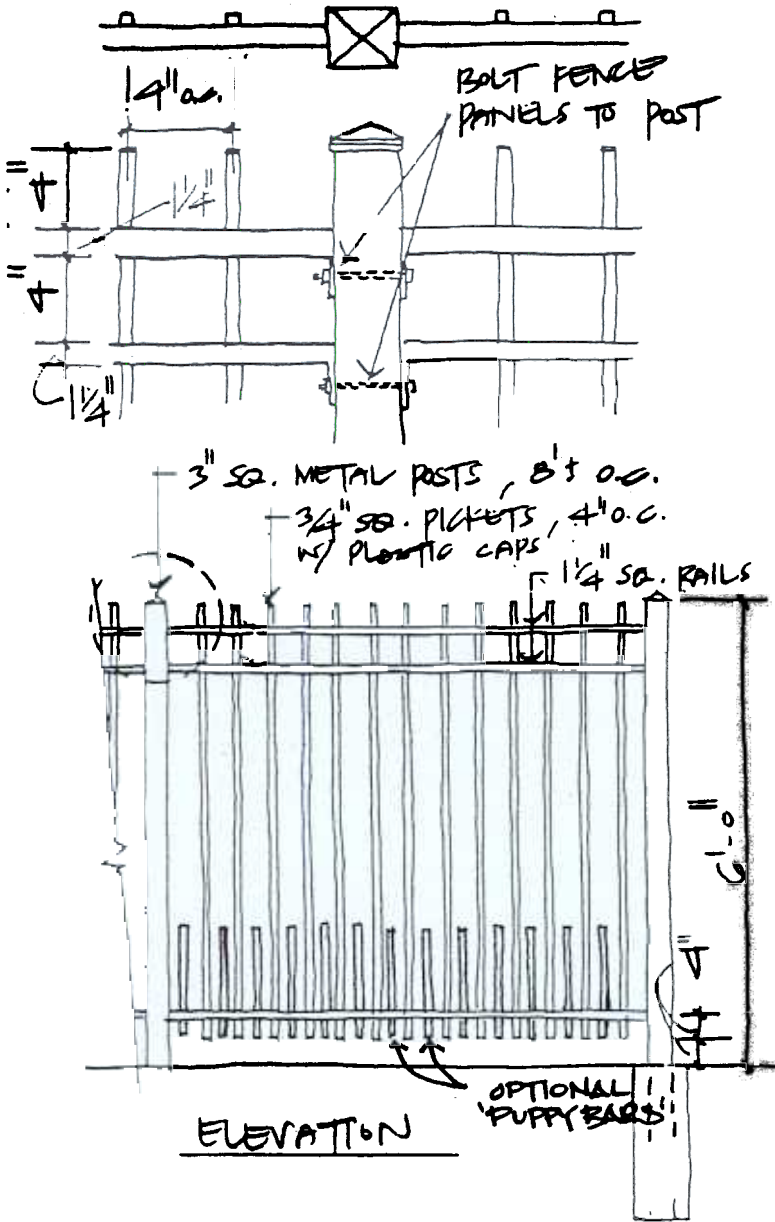

# LANDSCAPE

Minimum Residential landscaping requirements •  
The Manor Estates

*All landscaping requirements must be completed no later than 30 days after move in.*

## TREES

Four machine dug and two thirty gallon (30 gal.) container grown trees selected from the plant material list (preferred specimen trees) in the Landscape section of the Gleannloch Farms Residential Design Guidelines are required on non-wooded lots in the Manor Estates section. It is recommended that at least one of the required trees be a loblolly pine or oak tree. The required trees must be a minimum of 4" caliper. When lots front and side on two streets, there shall be an additional two trees for side yard. Lots adjoining golf course, lakes or open spaces require three additional trees in rear or side yard. Pine trees are preferred, but the ARC may consider other large trees of equal size from the approved plant list, for variances.

## SHRUBS

Manor Estate lots require the planting of a minimum of 70 small one gallon shrubs and 40 large five gallon shrubs. Plants used as minimum requirements shall be selected from the approved plant list.

Planting beds are to be curvilinear with the shrubs massed in tiers - smaller shrubs in the front of the bed. Groupings of shrubs of the same species provide a substantial look. A single row of foundation planting is not acceptable. Radius beds 10' minimum from building and vary widths of beds. Mulch all beds with 2" shredded pine bark. No gravel or rock of any size or color is permitted for use or substitution for shrubs, ground cover, mulch or grass lawns. Specimen boulders and stone borders are permitted.

The entire yard must be solid sod St. Augustine grass and have an irrigation system installed.



# SITE LAYOUT

---

## Lake Lots

Lots backing or siding onto Gleannloch Lake offer special design opportunities. Because they are open to public view, backyards become as important as front yards. All areas in public view must be solid sod. Care is to be given to enhance this special character and to insure the intrinsic value of this limited number of lots.

The lake is an ecosystem for aquatic plants and fish and will be under control of lake management professionals. Separate guidelines or rules will be published and made available to lake front property owners. These guidelines will deal with fishing (catch and release allowed only), controlling fertilizer, pesticide, petroleum product residue, and etc. around the lake. Dumping of leaves and grass clippings is prohibited. Soil runoff into the lake is to be kept at a minimum during and after residential construction. Use silt fencing during construction at rear property line of lake lots. Attention to these guidelines is imperative to the development of these lots.

## Grading

Lots shall be graded with drainage away from the lake. Lots should generally be drained from the back to the front at a minimum slope of 1% taking care to not place fill within the dripline of a tree. Silt fencing at the shoreline must be installed and kept in place during all construction activities on lake lots. No trash shall be permitted to enter the lake and no paint or chemical washout in or near the lake shall be permitted.

# LAKE LOTS

## The Manor Estates of Gleannloch Farms

### *Block 2 - lots 1, 2, 3, 4*

- There is a 40' rear setback on all lake lots.
- No bulkheads are permitted.
- Homeowner must maintain lot up to water's edge.

### Fencing

The rear and side of lots backing on the lake shall be fenced at the builder's/owner's expense with a 48" high iron fence that shall return no less than 40' toward the adjacent street. A fence and/or gate 48" high and perpendicular to the side lot line, may be used to enclose the property as long as it is set 20' back from the lake (this is to preserve the 20' lake easement). Rear yard privacy screens, up to 72" high, are permitted with a maximum of 15' of length for sides of walls perpendicular or parallel to the rear lot line. Screens may be no closer than 48" from the adjacent side lot line and may be of wood, masonry (preferably matching primary residence construction), or shrub hedge.

### Patios

Paved patios may be placed in the rear yard but shall not extend beyond the property line to the water's edge. All construction plans, with details, shall be submitted to the ARC, including landscape and irrigation plans, for review.

### Water Craft Restrictions/Storage

Use of boats on Gleannloch Lake shall be limited to non-motorized or electric boats subject to prior approval of the ARC. Canoes, paddle boats, etc. may not be in public view if unused for longer than a 24 hour period.

### Docks/Piers

No dock, pier or other artificial structure may be extended into Gleannloch Lake from lots.

# SITE LAYOUT

## Greenbelt Lots

Lots backing onto greenbelts, golf courses and other areas designated as common open space are to be fenced with wrought iron of a standard design as shown in the Residential Design Guidelines. This fencing is required to promote a feeling of spaciousness for the lots and the open space. These lots may have direct access to the open space via gates in the iron fence. Gates may be installed at the option of the builder or lot owner. Rear and side lot fencing is further defined in these supplemental guidelines.

The back yards of these lots must be treated in the same way as the fronts of the lots. The entire yard must be solid sod St. Augustine grass and have an irrigation system installed. A minimum of 40 small shrubs (one gallon) and 20 large shrubs (5 gallon) is required in back yard. The back yards will be in full view of residents, guests and golfers. Provisions are made in these guidelines for privacy fencing or screening.

To open up the greenbelt and to avoid creating an alley effect, rear and side lot lines are required to be fenced with a 48" high iron fence using the design illustrated in the fence section. This fence is to be placed on the rear lot line and return no less than 40' on lake lots and 25' on golf course lots, down side lot lines. Certain lots may be further defined in these Supplemental Guidelines.

Privacy fencing is permitted, but must be done according to the following guidelines. Privacy screens must be set back a minimum of 40' from rear property line and must not be more than 50' in length parallel to the rear property line. Dog kennels, storage yards, wood piles, etc. are not to be visible from public view. Creating and maintaining a backyard that is viewed from open space and from nearby residences offers the chance for special design concepts. Privacy screening is not allowed on golf course lots.

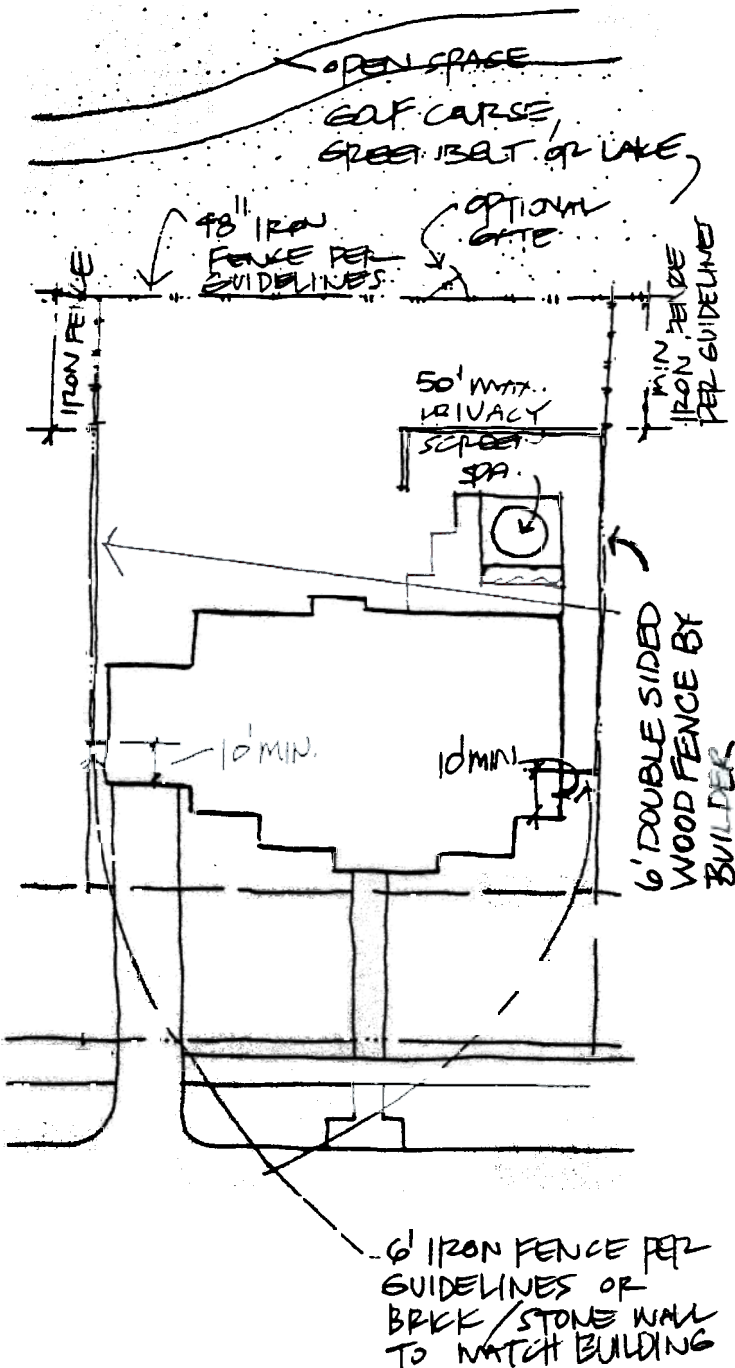

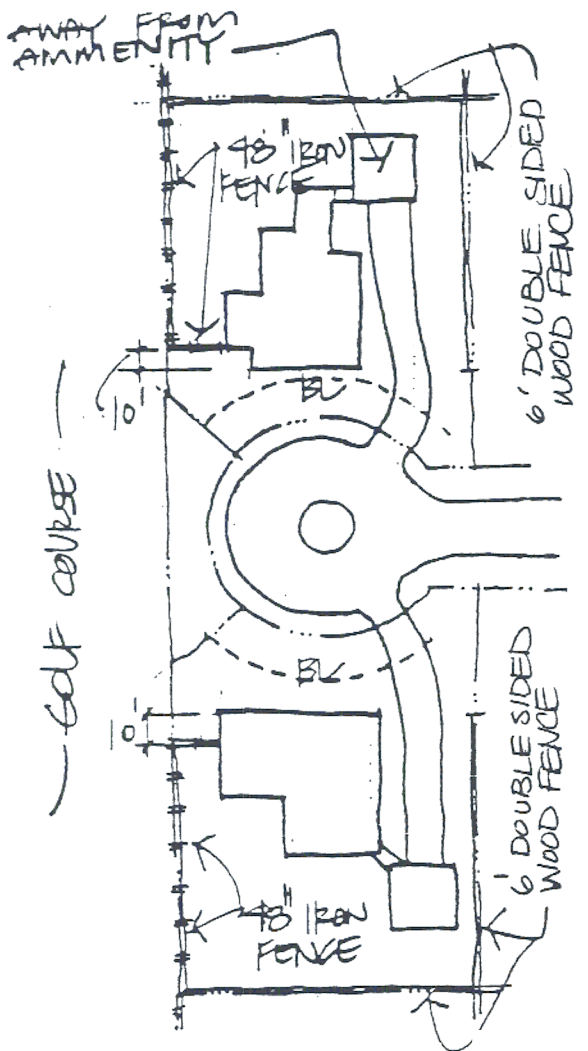

LOTS SIDING ON GOLF COURSE

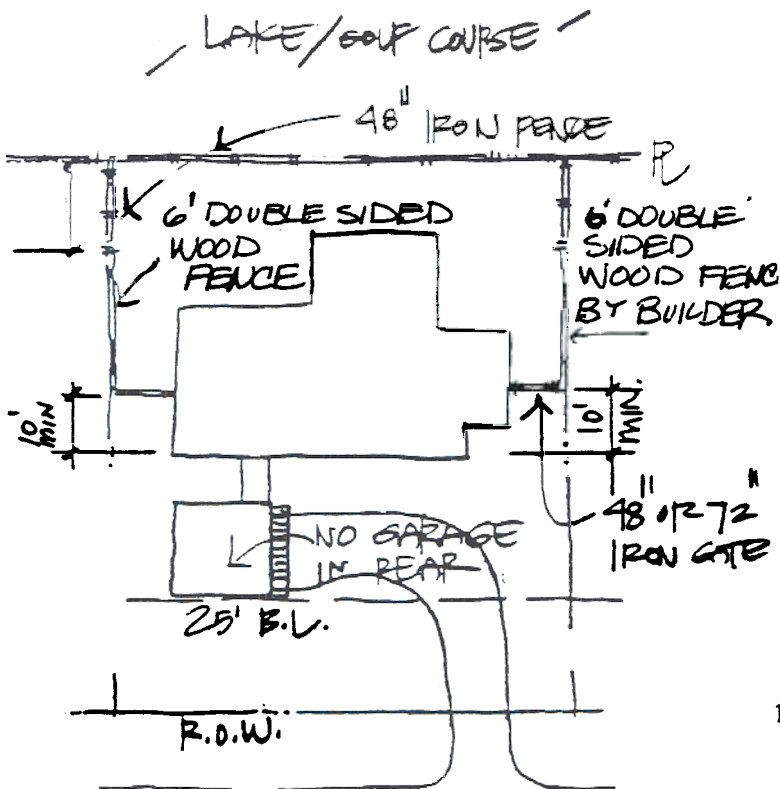

LOTS BACKING ON GOLF COURSE

## SITE LAYOUT

### Golf Course Lots

Lots adjacent to the Gleannloch Farms Golf Course are to be developed to derive the full potential of open space and views of golfing activities. Therefore the residences and grounds should be equally pleasing when viewed from the golf course.

The golf course has been designed using generally accepted criteria for golf course subdivisions, with adequate distances between fairways and residential lots. Design consideration for buildings, site layout and landscape planting should be addressed to protect against the possibility of errant golf balls. Large pane glass windows are discouraged. If a great amount of glass is desired, it should be in smaller, easier to replace panes. Strategic siting and tree planting can be accomplished for additional safeguards. Golf course lots will have a 25' front setback and a 25' rear setback.

Fencing of property lines adjacent to the golf course must be done according to the design criteria, illustrated in the fence section, by the builder or lot owner.

No structure, including a detached garage, may be built past the 25' rear setback line.

No detached garages are permitted on golf course lots.

## GRAPHICS

### Custom Home Builder Sign

One sign per single family lot allowed until occupancy.

Information to be conveyed:

Gleannloch Farms Logo

Name of Builder

Phone Number - Central Sales Office

24" x 32" sign panel may use Builder's name and/or logo or trademark. Colors and graphics are to be submitted to Architectural Review Committee.

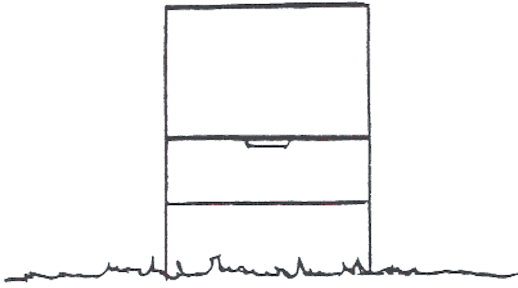

# ARCHITECTURE

## Outbuildings

Any structure on a lot other than the residence, detached garages, gazebos, and children's play equipment shall be considered an outbuilding. Generally outbuildings are used for storage or as tool sheds. Outbuildings shall not exceed 10' x 10' (100 square feet), and shall be no more than 8' high. They shall be located no closer than 3' from side property lines and on the side of the lot farthest from public view of streets, golf courses and common open space or in a location that is the least obtrusive.

Building materials, paint color and roof shingles shall be compatible and blend with the residence.

GOLF COURSE OR  
OTHER PUBLIC VIEW

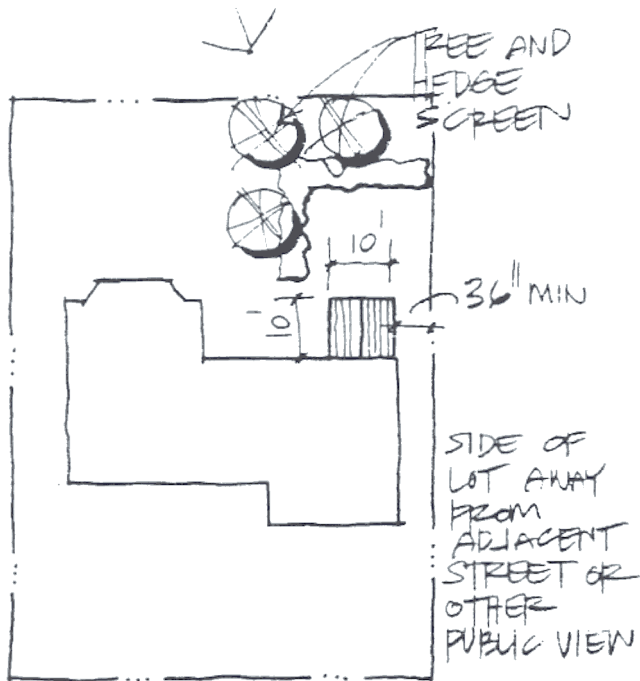

SITE REQUIREMENTS

# ARCHITECTURE

## Gazebos/Shade Structures

Freestanding structures for shade and ornamentation may be placed in rear and side yards behind fences. Gazebos may be octagonal, hexagonal, round or square with conical or hip type roofs less than 12' high, measured from the ground plane.

Associated decks or paved slabs shall not be more than 2' above the ground plane.

Arbor or trellis type shade structures are also permitted but shall not exceed 10' in height. The roof of these structures may not be used as an elevated deck for outdoor seating.

Gazebos/shade structures are not permitted closer than 20' from any side property line and 40' from the rear property line, and shall not encroach on any utility easement.

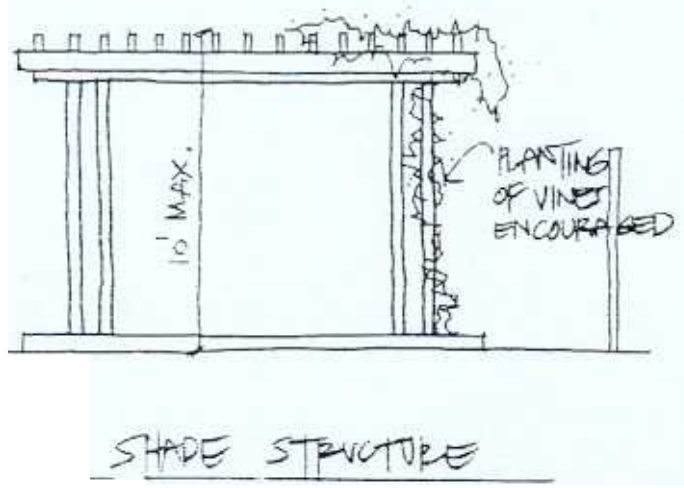
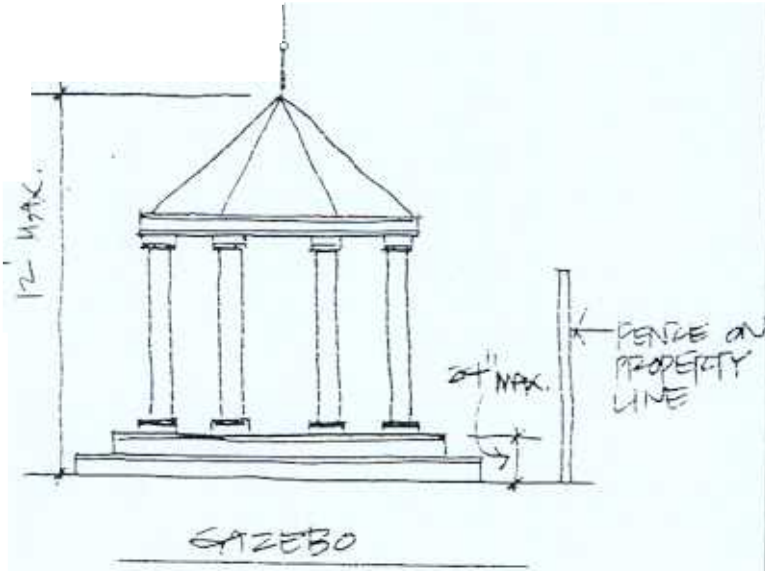

# ARCHITECTURE

## Mailboxes – The Manor Estates

All Section sixteen mailboxes are to be of the design shown at left. A 53" high stone column with classical brass mailbox. Mailbox available through: "Salsbury Industries" phone # 1-800-725-9393  
1010 East 62<sup>nd</sup> Street  
Los Angeles, CA 90001

Mailboxes are to be constructed of "Oak Ridge Gold" natural stone (San Jacinto Stone Co.). Mortar shall be a colored mix by "Chemsystems" – number MC43. Add 2 lbs. per sack of concrete.

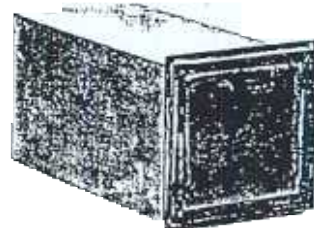

- 4545 Classical Brass - recessed mounted
- 9-1/2" W x 9-1/2" H x 17-1/2" D
  - rough opening: 8-1/2" W x 9" H x 18" D
  - 15 lbs.

CAST STONE ADDRESS MARKERS (MODEL # M1253) ARE AVAILABLE FROM: STEWARTS ARCHITECTURAL CAST STONE (713) 861-7923  
357 YALE HOUSTON, TX. 77007

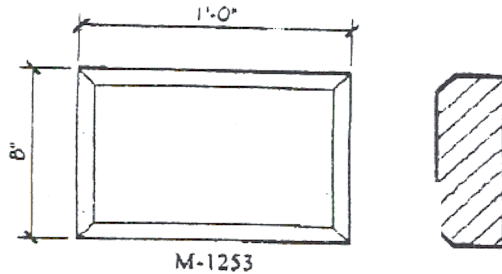

TYPICAL ADDRESS MARKER

**1234**

TYPICAL TEXT FONT

PAINT NUMERALS  
"CEDAR GREEN"  
(SHERWIN-WILLIAMS  
PAINT CO.)

GLEANNLOCH FARMS DESIGN GUIDELINES

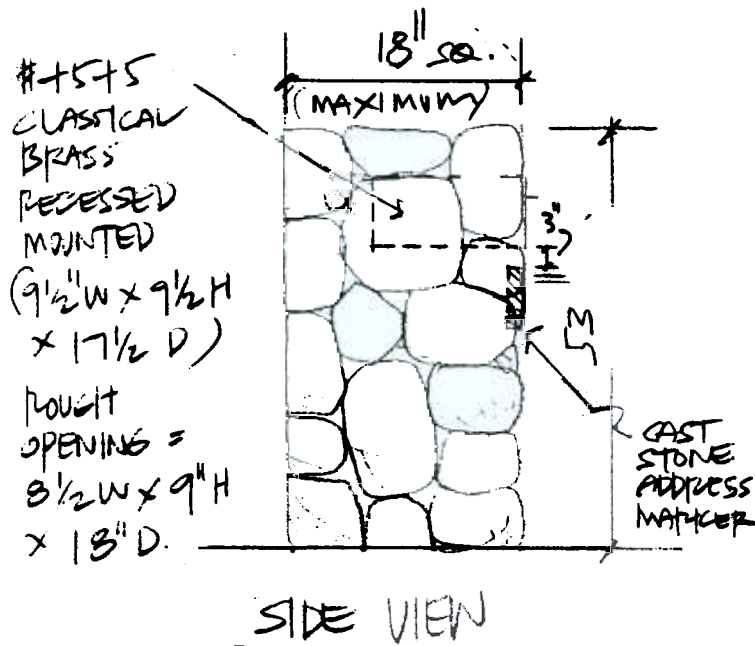
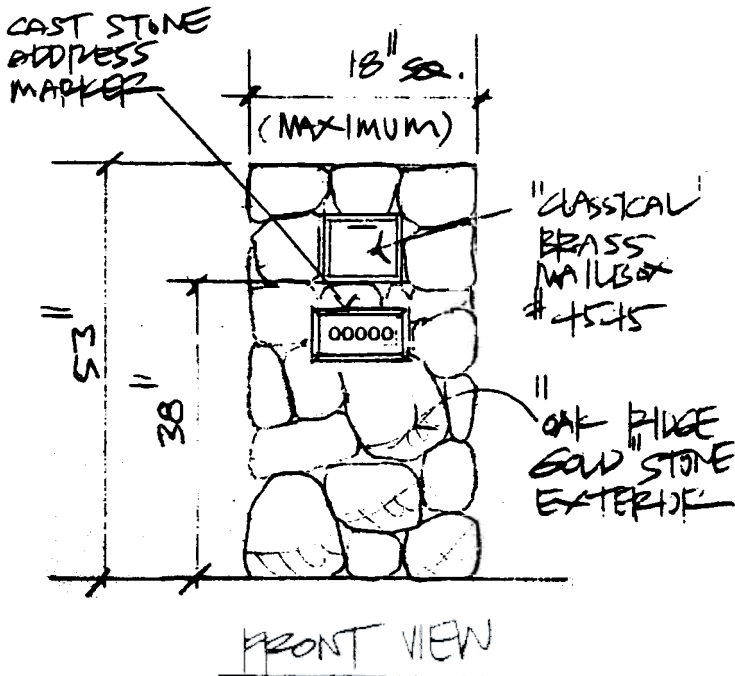

NOTE NO "ROUNDED" COLUMN TOPS



# SITE LAYOUT

---

## Water Wells

Private water wells are prohibited on all residential lots in Gleannloch Farms Subdivision, regardless of lot size. Prohibited water wells include those intended as a source of water for irrigation, ponds, swimming pools, heat exchange air conditioning systems and potable water. All water use in Gleannloch Farms Subdivision is under the jurisdiction of Harris County Municipal Utility District No.367.

## GLEANNLOCH FARMS SECTION SIXTEEN REVIEW PROCESS

### I. Architectural Review Committee

The design for each residence in Gleannloch Farms must be approved in writing by the ARC before construction of the residence, or other modification or improvement can begin. The ARC consists of members who work in conjunction with the Declarant and the Association to uphold the architectural control standards for Gleannloch Farms. The ARC is committed to ensuring a high level of design quality within the community by reviewing residential and landscape design submissions for Gleannloch Farms residences. This review process is intended to correct problems with submitted designs and prepare them for acceptance into the community.

The ARC meets on a biweekly basis to review design submittals. Initial contact between the ARC and the party submitting the design shall be made within four (4) weeks of the meeting at which that design is to be reviewed and a decision shall be transmitted within a maximum of forty five (45) days.

Each plan (2) will be accompanied with a \$250.00 review fee check made payable to the GFCA Inc. In addition, for each lot within the subdivision, two (2) copies of the plot plan must be submitted for approval, along with a \$100.00 check (\$25 review fee and \$75 conditional compliance letter fee). The deadline for re-submittals is the Thursday (at 6:00 pm) before the Tuesday (9:00am) meeting. The plan number, elevation, lot, block, section, subdivision, and building lines must be indicated on the submittal. (schedule is subject to change) Submittals shall be sent to the attention of the:

Gleannloch Farms Community Association, Inc.  
9575 Katy Fwy. , Suite 130  
Houston, Texas 77024-1453  
(713) 932-1122 Fax (713) 932-6059

### II. Notice of Approval

The design for each residence must be approved **in writing** before construction of the new residence can begin. Construction begun prior to approval is in violation of The Declaration of Covenants, Conditions and Restrictions for Gleannloch Farms, and may be subject to fines, change or removal. Deviation from approved construction documents during construction (without written approval by the ARC) constitutes a violation of the Declaration of Covenants, Conditions and Restrictions. **On the ARC's authority, corrections of such deviations will be required. Approvals/Disapprovals will not be discussed over the phone.**

### III. Final Architectural Submittals

A. Requirements – The ARC requires that each final design submittal consist of two (2) sets of the following:

1. Design Development Plan, Including:
  - a. Floor Plans and Elevations
  - b. Materials (brick, stucco, stone, paint) – colors and samples
  - c. Landscape plans
  - d. Tree survey
  - e. Residential checklist (obtain from ARC)
  - f. Submittal fee of \$250.00 (per plan, per neighborhood) in the form of a check made payable to GFCA, Inc.
2. Plot Plan – plot plans must be submitted for each lot indicating:
  - a. Neighborhood, section and block
  - b. Floor plan, elevation, fence and sidewalk plan
  - c. Submittal fee of \$25.00 for each plot plan
  - d. Conditional Compliance letter fee of \$75.00 – plans will be approved on a conditional basis, provided that construction proceeds according to plans and any changes made by the ARC.

B. The design for each residence must be approved in writing before construction of the residence can begin. Deviation from the approved construction documents during construction (without written approval by the ARC) constitutes a violation of the Declaration of Covenants, Conditions and Restrictions. On the ARC's authority, corrections of such deviations will be required.

#### C. Review of Construction

The ARC reviews construction in Gleannloch Farms on a regular basis to endeavor to confirm that the design of each residence is approved. This review process allows builders to address any difficulties of compliance with the ARC, thereby enhancing the design integrity of the residence and the community as a whole.

D. All modifications and new construction contemplated must be submitted to the ARC. New construction means anything to be built; placed on the property, including **but not limited to**:

1. Fencing
2. Pools
3. Gazebos
4. Basketball Goals
5. Decorative Construction (patio covers)

6. Play Equipment
7. Mechanical Equipment
8. Window Film
9. Landscape Additions
10. Paint

**IV. Fine Schedule**

A fine schedule has been adopted by the GFCA, Inc. Notice is considered to be given upon submittal of the first plan.